



**MCB-125/126 MULTIFUNCTION DIGITAL TIME RELAY
With 1 CO Contact
Operating Manual**



Dudullu OSB; 1. Cadde; No: 23 34776 Umraniye - ISTANBUL / TURKEY

Tel : +90 216 313 01 10 **Fax** : +90 216 314 16 15

www.entes.com.tr

Precautions for Installation and Safe Use

If below precautions are not properly observed and carried out, it may result in cases with injury or death.

- Disconnect power before working on the device.
- When device is connected to the network, do not remove the front panel.
- Do not clean the device with solvent or similar items. Only clean with dry cloth.
- Verify correct terminal connections before energizing the device.
- Install the device on the electrical panel.
- Contact your authorized reseller in case problems occur with your device.

 **No responsibility is assured by the manufacturer or any of its subsidiaries for any consequences rising out of not following above precautions.**

1. INTRODUCTION

MCB-125/126 is a multifunction digital timer with 1 CO contact. It offers wide time adjustment range between 0.1-9999 seconds/minutes.

1.1 Application

MCB-125/126 has 21 different functions with wide adjustable time ranges. The main application area is the industrial and automation control systems.

The device has two dry contacts for START and STOP inputs.

1.2 Product Features

MCB-125/126 has the following features:

- 85-315 VAC/DC - MCB-125
- 10-30 VAC/DC - MCB-126
- 21 different functions
- 0.1-9999 seconds/minutes time range
- 1 relay output
- Start-Stop dry contact inputs
- Memorizing remaining time of function in case of a power outage
- Custom design LCD with green backlight
- SET, ESC, UP, DOWN buttons are located on front panel for easy programming
- PK25 DIN Rail mounting

1.3 Hardware Features

To operate functions with external triggering, the device has the necessary START and STOP dry contacts.

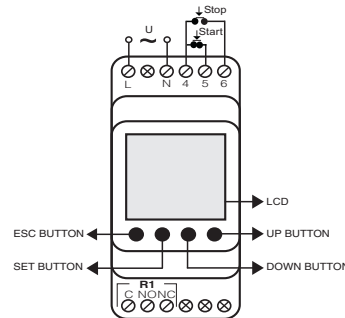

1.3.1. Display

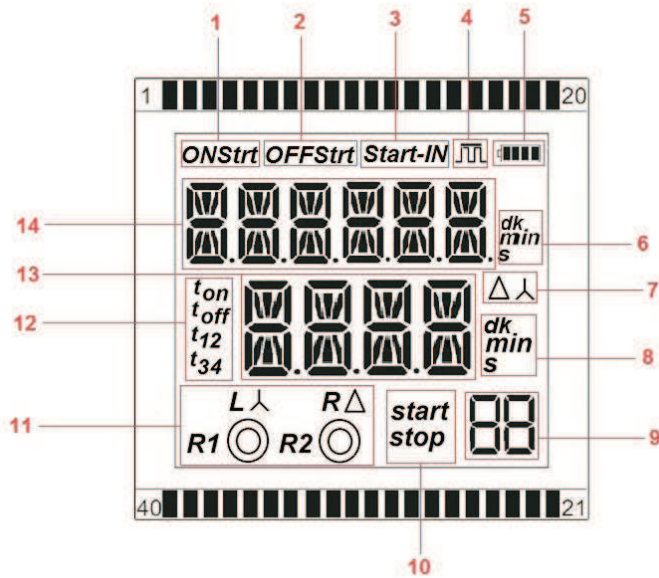

1. **ONStrt** : Indicates that the relay will start as closed.
2. **OFFStrt**: Indicates that the relay will start as open.
3. **Strt-Input Icon**: Indicates that the function is started with external input.
4. Indicates whether function trigger is Level or Edge.
5. Battery
- 6 and 8. min sec : Indicates whether timing unit is minute or second
7. Time setting indicator for Star-Delta function
9. Numeric Two Digits: Show function number.
10. **Stop**: Indicates that stop input is active. **Start**: Indicates that stop input is active.
11. When R1 or R2 relays are activated, the center of the circles are turned on. **R** and **L** letters are used to indicate left or right direction when inverter relay function is selected. **Star-Delta**: Indicate the output relay state in Star-Delta function.
12. Indicates the time type of functions.
13. In the main menu, it shows the elapsed time.
14. In the main menu, it shows the entered time. In the settings menu, it shows the function names.

1.2.2 Button functionality

SET, ESC, UP and DOWN buttons help to select functions and set their times.

UP button goes to previous menu item in Settings Menu and increase selected parameter value.

DOWN button goes to next menu item in Setting Menu and decrease selected parameter value.

SET button is for entering data. When pressed at least 3 seconds, Setting Menu is selected.

ESC button exits from a menu.

1.2.3 Outputs

MCB-125/126 has one changeover relay output. According to VDE 0110 and IEC 60947-1 standards; switching capacity of relay output is 8A, 2000VA, 250 V. and maximum electrical life time is 1×10^6 .

1.2.4 Inputs

1.2.4.1 Start Input and Stop Input:

These inputs are voltage-free dry inputs.

Start Input: For some of the functions, output depends on the state of the start input or input pulses from start input. When user shorts two terminals of this input, start input activates.

Stop Input: When stop input applies, the timing pauses with stop input's leading edge. When stop input is removed, the timing continues to count from it's last value with stop input's trailing edge. Stop input affects all functions as the same without any exception. When user shorts two terminals of this input, stop input activates.

An Example: This function needs t_d delay time to release relay. When stop input is applied, it stops counting and saves the time t_1 . With stop input's trailing edge, counting continues from the saved time t_1 until delay time t_d (Here $t_d = t_1 + t_2$). While stop input is active, the relay doesn't change its position.

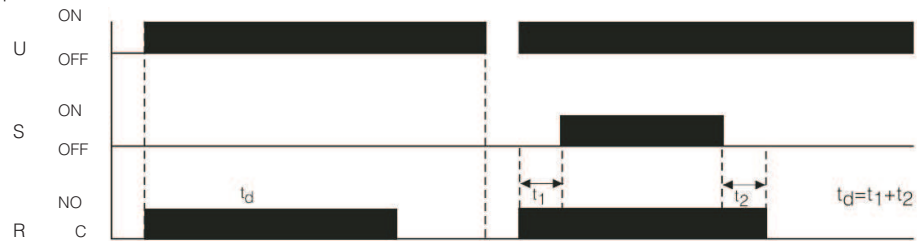

U : Supply Voltage

Stop : Stop Input

R : R1 Relay

t_d : Delay Time

t_1 : Time elapsed until Stop Input is activated ($t_1 < t_d$)

t_2 : Time elapsed after Stop Input is deactivated ($t_d = t_1 + t_2$)

2. OPERATING INSTRUCTIONS

When the device is taken out of the box, an installation menu will be displayed. Language and function settings are done in this menu as seen in the figure below. Afterwards, device returns to main menu and starts operating.

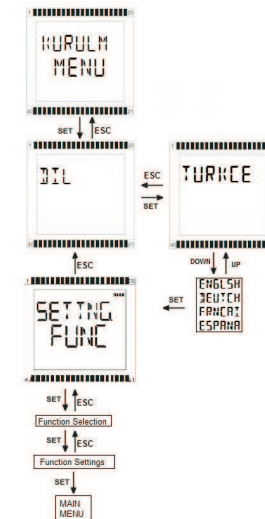

To enter Settings Menu, press SET button for 3 seconds. If password is active, entered the password (It is "0000" by factory default). If password is not active, Settings menu is displayed directly.

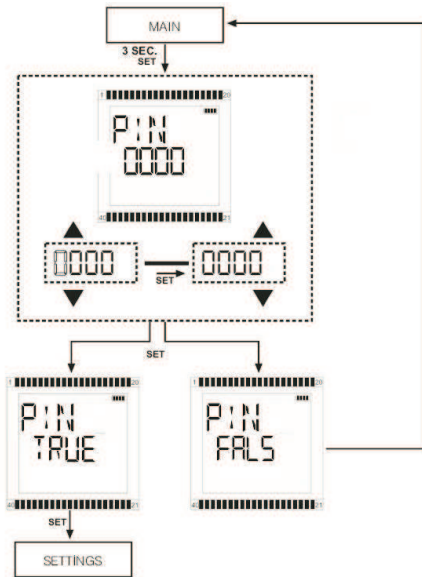

7

Basic settings map is shown below. There are two main submenus as function selection and display settings.

Function Selection Submenu: A new function is set from function selection menu. In this submenu, user chooses a function, sets t parameter/parameters for selected function; assigns relay output and selects the activation of memory feature to keep remaining timer value.

Display Configurations Submenu: Changing password, adjusting contrast, activating backlight or changing language is done from this submenu.

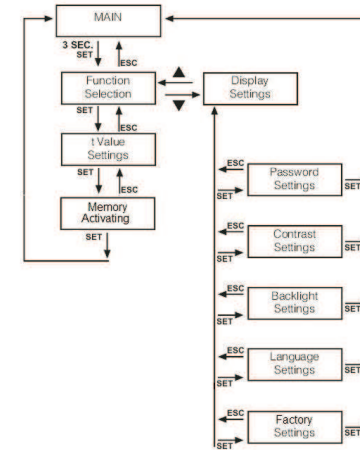

8

2.1 Functions:

1. On Delay

When supply voltage is applied, "td" begins. At the end of the adjusted time, the output relay

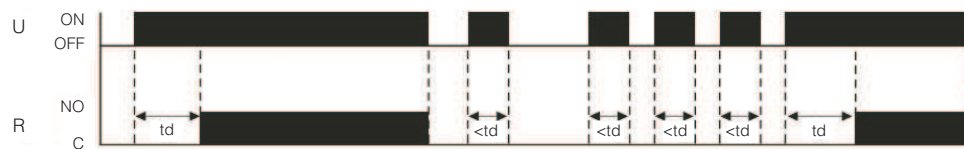

U :Supply Voltage
R :R1 Relay
td :Delay Time

2. On Delay / Start by external trigger leading edge

This function is controlled by start input after supply voltage is applied. Time counting starts with the leading edge of the start pulse; at the end of time "td" the output relay is activated and remain activated while start input pulse is ON

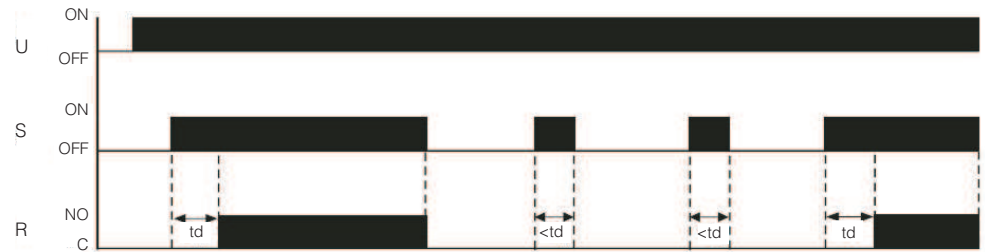

U : Supply Voltage
S : Start Input
R : R1 Relay
td : Delay Time

3. On Delay / Start by external edge re-trigger

This function is controlled by start input after supply voltage is applied. Time counting starts with the leading edge of the start pulse; at the end of "**td**" time, the output relay is activated and remain activated until next start pulse is applied.

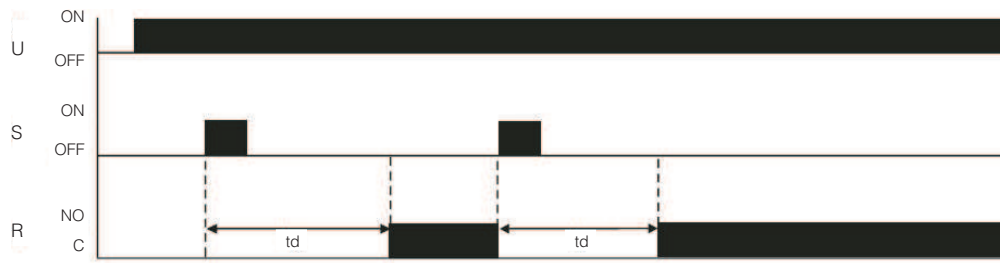

4. Off Delay

When supply voltage is applied, output is activated and "**td**" time begins. At the end of the adjusted time, the output relay is deactivated.

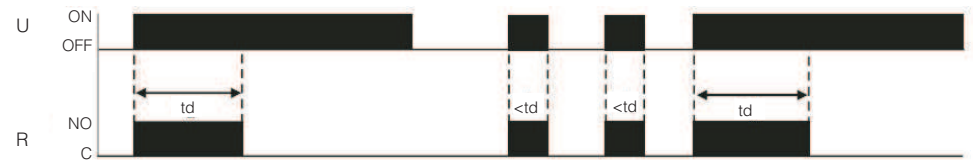

5. Off Delay / Start by external trigger trailing edge

This function is controlled by start input after supply voltage is applied. Output Relay is activated when start pulse is applied and remains on; time counting starts with the trailing edge and output relay is deactivated at the end of delay time "td". If trigger pulse occur during time counting period, elapsed

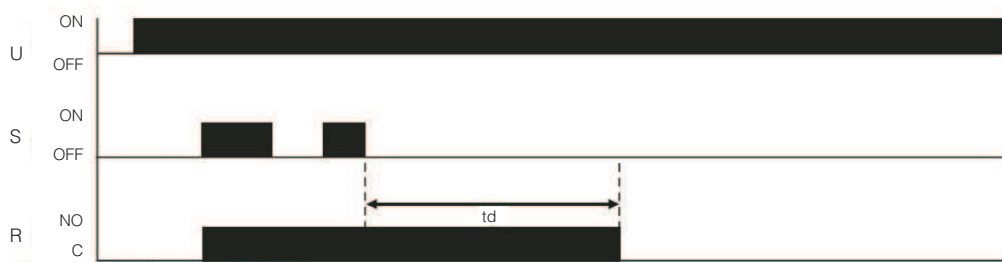

6. Flasher / Relay ON start

When supply voltage is applied, output relay is activated and "ton" time begins. At the end of ton time, output relay is deactivated and "toff" time begins. This cycle is repeated while supply voltage is applied.

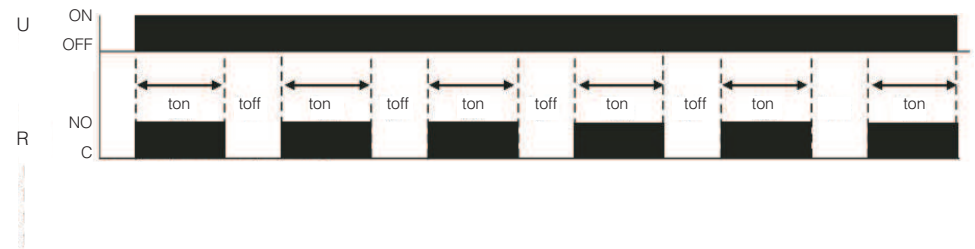

7. Flasher / Relay ON start

When supply voltage is applied, "toff" time begins. At the end of ton time, output relay is activated and "ton" time begins. This cycle is repeated while supply voltage is applied.

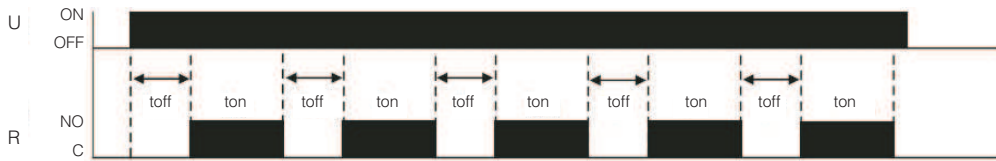

8. Flasher / Start by external trigger leading edge / Relay ON start

This function is controlled by start input after supply voltage is applied. With the leading edge, output relay is activated and remain on during "ton" time. It is deactivated when "toff" time starts. This cycle is repeated while start pulse is on (high).

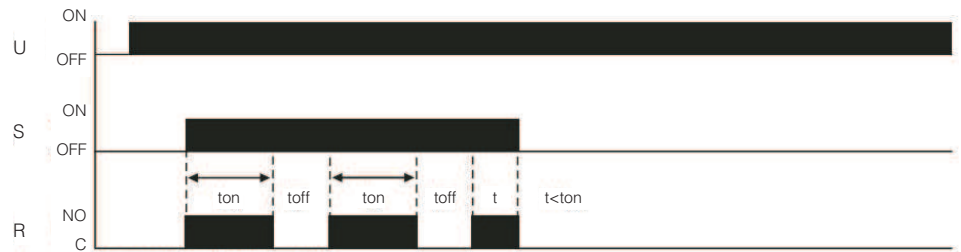

9. Flasher / Start by external trigger leading edge / Relay OFF start

Function is similar to the ON Start version (function 8) with the exception that the output relay starts as passive.

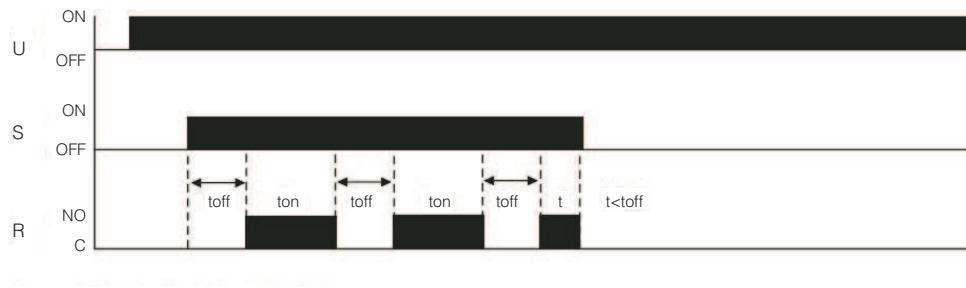

10. Flasher / Start by external edge - retrigger / Relay ON start

This function is controlled by start input after supply voltage is applied. With the leading edge, output relay is activated and remain on during "ton" time. After that, it is deactivated and "toff" time starts. This cycle is repeated until the next edge-retrigger pulse. If a trigger pulse occur during "ton", time counting is reset and "ton" time counting is restarted.

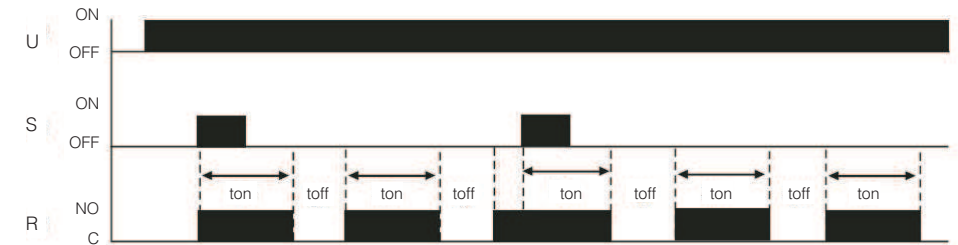

11. Flasher / Start by external edge - retrigger / Relay OFF start

Function is similar to the ON Start version (function 10) with the exception that the output relay starts as passive.

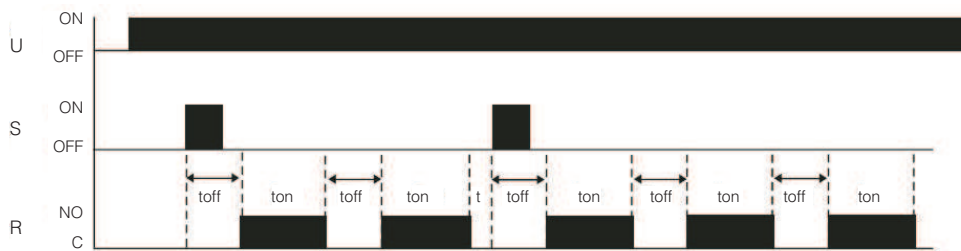

12. Adjustable ON Delay by external trigger leading edge

This function is controlled by start input after supply voltage is applied. When the Start Input is closed, the cycle starts with adjustable "toff" delay time. At the end of delay time, output relay is activated and remain activated during "ton" time. After "ton" time, the output relay is deactivated. If the Start Input is deactivated and activated, function will be reset.

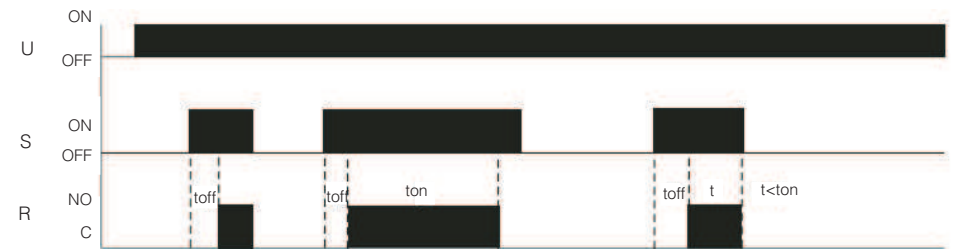

13. Adjustable and Resettable ON Delay Pulse by external trigger leading edge

This function is controlled by start input after supply voltage is applied. The cycle starts with adjustable "toff" delay time after a pulse is created at the Start Input. At the end of delay time, output relay is activated and remain activated during "ton" time. If a re-trigger pulse occurs during "toff" time, elapsed time is reset and "toff" counting is restarted.

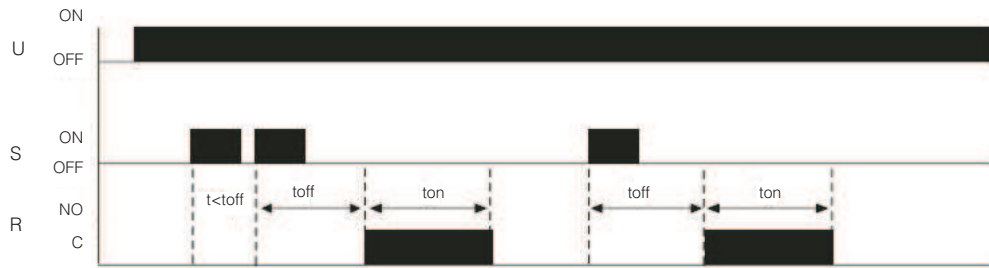

14. Adjustable OFF Delay Pulse by External Trigger Leading Edge

This function is controlled by start input after supply voltage is applied. With the leading edge of the Start Input, output relay is activated and remain on during "td" time. After "td" time, the output relay is deactivated and stays that way until another pulse is applied to the Start Input.



15. Adjustable OFF Delay Pulse by External Trigger Leading Edge Re-trigger

This function is controlled by start input after supply voltage is applied. With the leading edge of the Start Input, output relay is activated and “**td**” time starts. After “**td**” time, the output relay is deactivated and stays that way until another pulse is applied to the Start Input. If another pulse is applied during “**td**” time, function is reset.

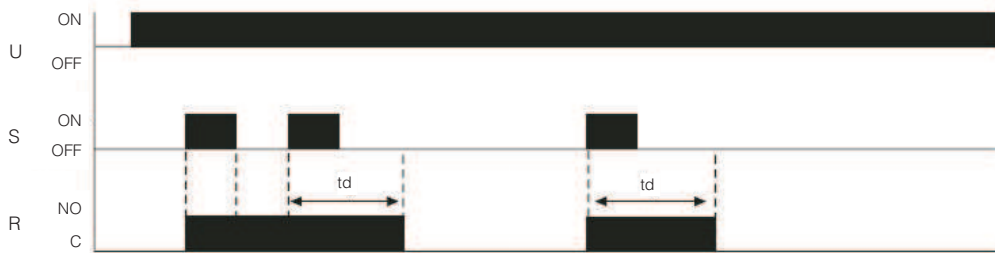

16. Adjustable OFF Delay Pulse by External Trigger Falling Edge Re-trigger

This function is controlled by start input after supply voltage is applied. With the falling edge of the Start Input, output relay is activated and “**td**” time starts. After “**td**” time, the output relay is deactivated and stays that way until another pulse is applied to the Start Input. If another pulse is applied during “**td**” time, function is reset.



17. Impuls Relay

When the device is energized, "t" time starts. At the end of "t" time, output relay activates for 0.5 seconds and then deactivates. The function restarts only when the supply voltage is removed and applied again.



18. Up Counter-1

After the device is energized, it starts to count with the first applied leading edge. When the pulse number equals to the adjusted "t" number, output relay activates. The output relay stays active until the user sets a new "t" number from the menu or supply voltage is removed and reapplied.



19. Down Counter

This function is controlled by start input after the supply voltage is applied. When start input is applied, counting down starts from the selected value. When this value reaches zero, the output relay activates. If control input retriggered, the output relay de-activates and the function is reset. If the Start Input is triggered before the countdown is finished, function is not affected. If the supply voltage is removed and reapplied, counting starts again.



20. Up Counter-2

Function is similar to the Up Counter-1 function with the exception that the user can adjust how long the output is going to stay active.

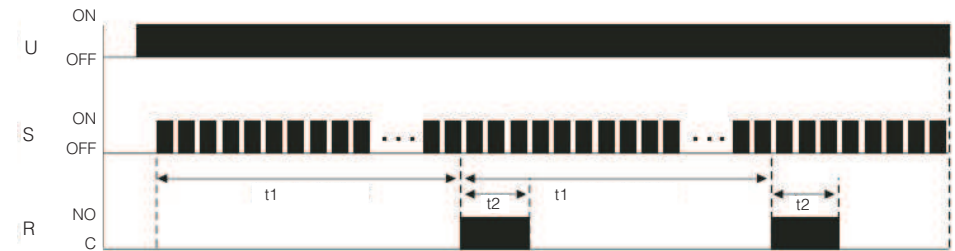

21. Latch (Start-Stop) Relay

This function is controlled by start input after the supply voltage is applied. This function does not require any timing value. When start input is applied, relay activates until a second pulse from start input. After receiving the second start input signal, relay deactivates until a third pulse from the start input. This process is repeated while the supply voltage is applied.

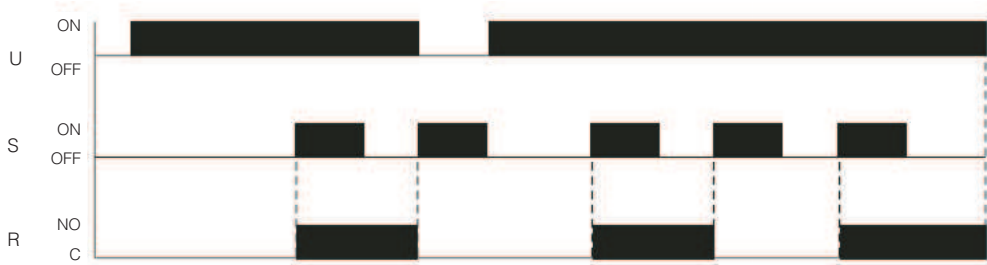

2.2 Settings

2.2.1 Function Selection:

Function sub-menu is reached by pressing SET button in Settings menu. The functions that the device offers can be browsed with UP or DOWN buttons. The user selects the desired function enters its adjustment menu by pressing SET button.

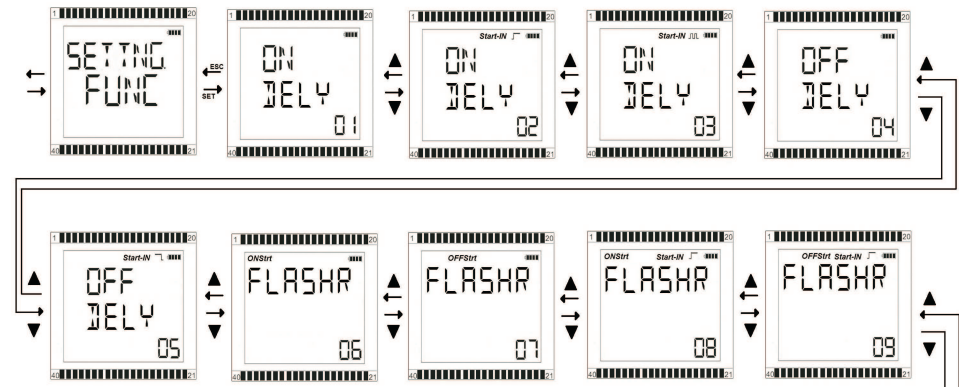

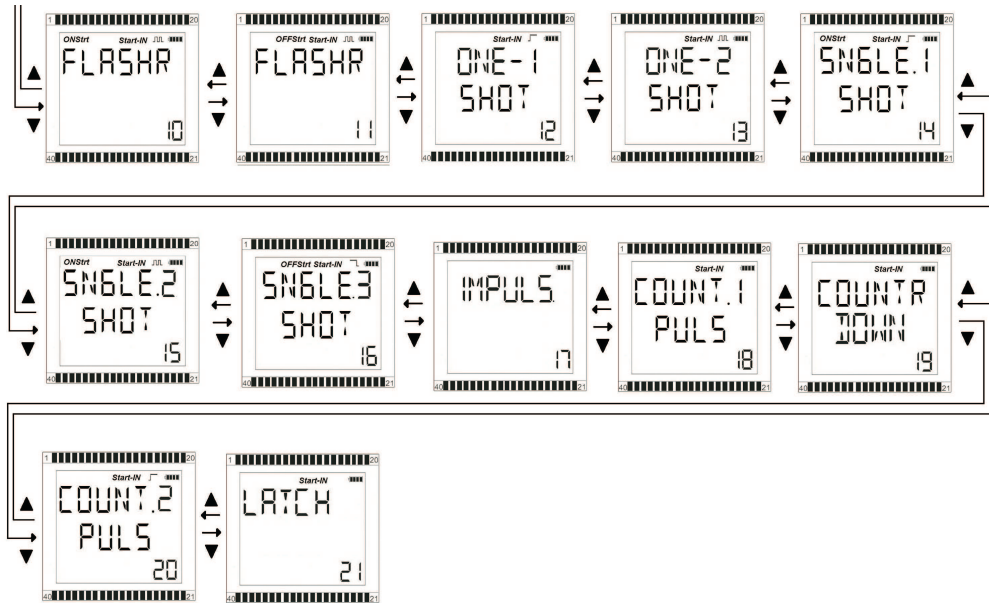

2.2.2 Time Setting :

After selecting the function, user sets t value/values according to the application need. Time range for "t" is between 0.1 seconds-9999 seconds and 0.1 minutes-9999 minutes. Setting starts from left digit towards right digit. User uses UP button to increase value of the digit and DOWN button to decrease. The user presses SET button to move to the next digit on the right and the ESC button to move back to a previous digit. After entering a number, user selects unit (minutes or seconds) by pressing UP or DOWN. Finally, the selected values are stored by pressing SET button.

Example Time Setting (0.1 - 9.9) :



Example Time Setting (10 - 9999) :



2.2.4 Memory

Device has an internal memory. If the memory option is activated while setting 2nd, 3rd, 6th, 7th, 8th, 9th, 10th, 11th and 20th functions; elapsed time and relay positions will be stored when the power goes out. When the power comes back on, the device continues from the stored time and relay position. If the memory option isn't activated while setting a function, elapsed time and relay positions are not stored in case of a power outage and the device starts the function from the start when the power comes back on.

FUNCTION SETTINGS

ON Delay :

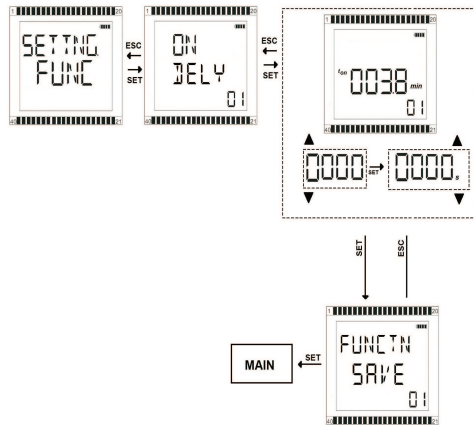

33

Flasher :

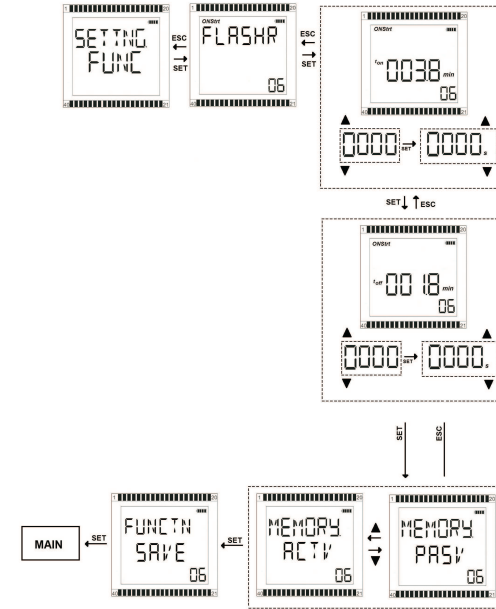

34

Single Shot :

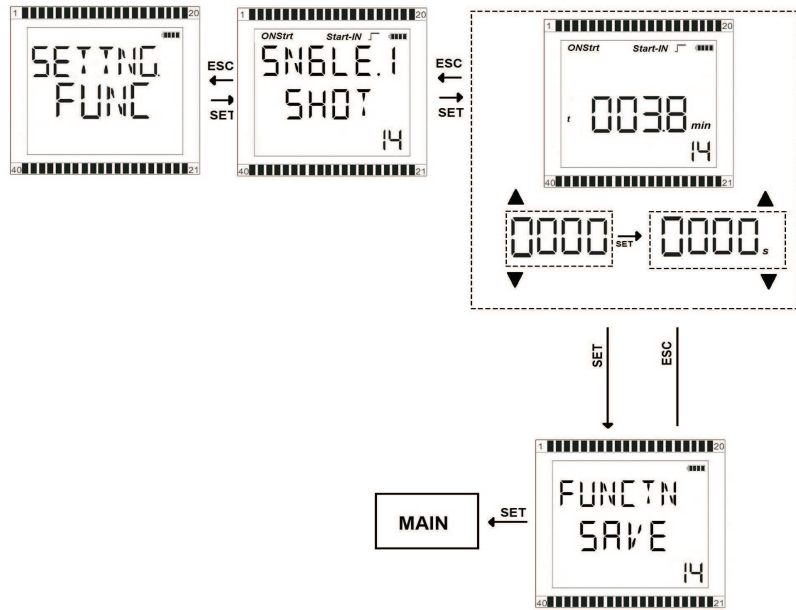

35

One Shot :

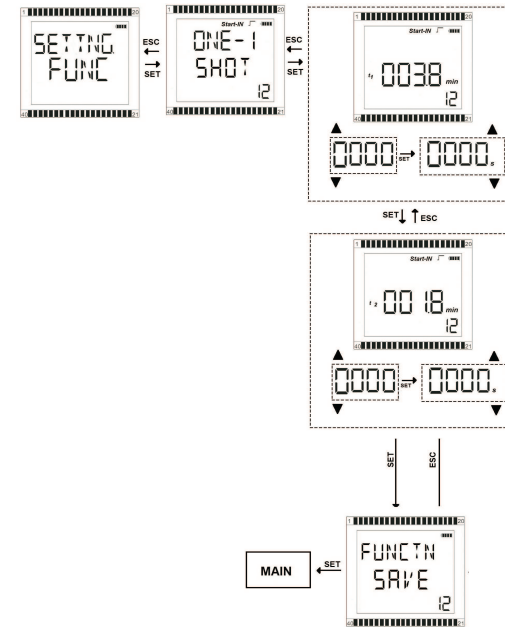

36

2.3.1 Display Settings :

In this submenu, user can change password, contrast, backlight and language settings and return to factory default settings. In Password submenu, user can activate or deactivate the password. To change password, the user should first enter current password, then new password twice. In Contrast menu, user can change contrast level from 1 to 5. In Backlight menu, user can choose a setting from “always on”, “always off”, “on for 5 seconds”, on for 10 seconds” and “on for 20 seconds” options. In Language menu, device supports 5 languages as Turkish, English, German, French, Spanish.

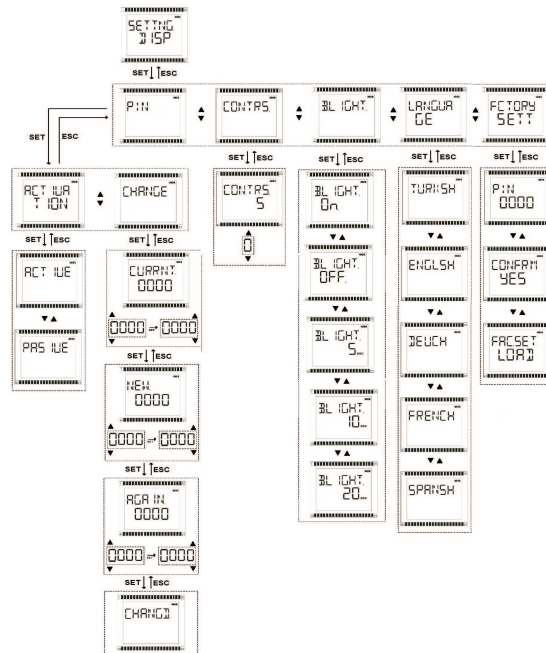

3 MAIN SCREEN

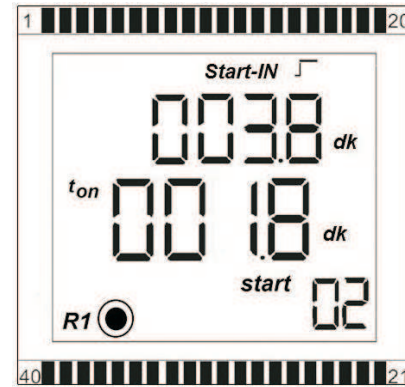

- This is an example to explain main screen.
- Top line shows the function: In this case, Onstrt (ON start), Strt- Input (Start Input) and Edge Trigger is selected.
 - First line shows the adjusted time.
 - Second line shows the elapsed time value.
 - “start” icon indicates that “Strt-Input” is active.
 - The number 01 indicate that 1st function is selected.
 - ● icon next to R1 indicates that R1 relay is active.

When UP or DOWN buttons are pressed while on the main screen, the name of the selected function is displayed. By pressing the ESC button, main screen is displayed again.

Connection Diagram :

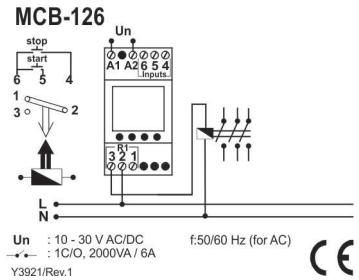
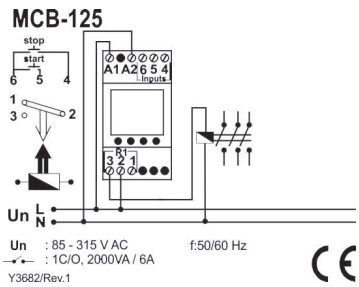

Dimensions :

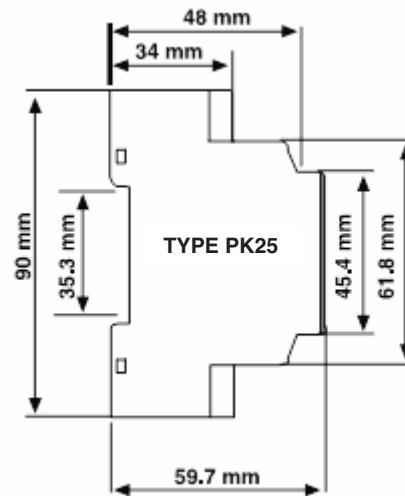

Technical Features

Input Circuits	85-315 VAC / DC - MCB-130
Operating Voltage	10-30 VAC/DC - MCB-131
Operating Voltage Tolerance	±20%
Operating Frequency	DC supply 0 Hz, AC supply 50/60 Hz
Input Contacts	2 Dry Contacts (Start, Stop)
Timing	Selectable
Time Range	0.1 . 9999 Seconds
	0.1 . 9999 Minutes
Reset Time	< 100 ms
Repetition Error	±0.2% of Adjusted Time
Timing Setting Error	< 0.5 %
Output Circuits	
Output Contacts	1 C/O Contact
Switching Capacity	6 A, 2000VA
Voltage according to VDE 0110, IEC 60947-1	250 V
Maximum Electrical Life	1x 10 ⁶
General Features	
Dimensions	Width 36.0 mm
	Length 90.0 mm
	Depth 59.7 mm

Cable Selection

2,5mm² stranded
4,0mm² solid
0.25 kg
Rail Mount
IP40 / IP20
+5...+50 °C

Weight
Installation
Enclosure and Terminal Protection Class
Operating Temperature

Standards
Product Standard

IEC 61812-1 10.1996, EN 61812-1 + A11/8.1999,
DIN VDE 0435 part 2021
2004/108/EC
IEC 61000-6-2, EN 61000-6-4
IEC 61000-4-2, EN 61000-4-2 (level 3 6 kV / 8 kV)
IEC 61000-4-3, EN 61000-4-3 (level 3 10 V/m)
IEC 61000-4-4, EN 61000-4-4 (level 3 2 kV / 5 kHz)
IEC 1000-4-5, EN 61000-4-5 (level 4 2 kV L-L)
IEC 1000-4-6, EN 61000-4-6 (level 2 10 V)
2006/95/EC
2002/95/EC

EMC Directives
Electromagnetic Compliance
ESD
HF Radiation Resistance
Burst
Surge
HF Line Emission
Low Voltage Directive
RoHs Directive

Isolation Data
Rated Impulse Withstand Voltage
Test Voltage Between All Isolated Circuits
Pollution Category
Overvoltage Category

VDE 0110, IEC 664 (4 kV / 1.2-50 ?s)
2.5 kV, 50 Hz, 1 min.
IEC/EN 60664-1, VDE 0110, UL 508 (3)
IEC/EN 60664-1, VDE 0110, UL 508 (III)

MENU MAP

